

# PC23d | PC43d | PC43t

## Label Dispenser Installation Instructions

标签剥离器安装说明

標籤剝離機安裝說明

Instructions d'installation du distributeur d'étiquettes

Installationsanleitung für Etikettenspender

Petunjuk Pemasangan Label Dispenser

Istruzioni per l'installazione del distributore di etichette

라벨 분배기 설치 안내

Instruções de Instalação do Alimentador de Etiquetas

Инструкции по установке распределителя этикеток

Instrucciones para instalar el dispensador de etiquetas

Etiket Dağıtıcısı Kurulum Talimatları

Turn the printer off and disconnect the power cable before you begin. Do not touch printhead while installing this accessory. For more information on using this accessory, see the *PC23 and PC43 Desktop Printer User Manual*.

开始前，请先关闭打印机并断开电源电缆连接。安装该配件时不要接触打印头。有关使用本配件的详细信息，请参阅 PC23 和 PC43 桌面型打印机用户手册。

開始前，先關閉印表機並拔下電源線。安裝此配件時請勿碰觸印字頭。關於使用此配件的詳細資訊，請參閱 PC23 及 PC43 桌上型印表機使用者手冊。

Éteignez l'imprimante et débranchez le câble d'alimentation avant de commencer. Ne touchez pas la tête d'impression durant l'installation de cet accessoire. Pour plus d'informations sur l'utilisation de cet accessoire, consultez le *manuel d'utilisation des imprimantes de bureau PC23 et PC43*.

Den Drucker ausschalten und vor dem Beginnen das Netzkabel abziehen. Bei der Installation dieses Zubehörs den Druckkopf nicht berühren. Weitere Informationen über die Verwendung dieses Zubehörs entnehmen Sie bitte der *PC23- und PC43-Desktop-Druckeranleitung*.

Matikan printer dan lepaskan kabel listrik sebelum memulai. Jangan sentuh head printer saat memasang aksesoris ini. Untuk informasi lebih lanjut mengenai penggunaan aksesoris ini, bacalah *PC23 and PC43 Desktop Printer User Manual*.

Prima di iniziare, spegnere la stampante e scollegare il cavo di alimentazione. Non toccare la testina di stampa mentre si installa questo accessorio. Per ulteriori informazioni sull'uso di questo accessorio, consultare il *manuale dell'utente della stampante desktop PC23 e PC43*.

시작하기 전에 프린터를 끄고 전원 케이블 연결을 해제합니다 . 이 부속품을 설치하는 동안 프린터 헤드를 만지지 마십시오 . 본 부속품 사용법에 대한 자세한 내용은 PC23 및 PC43 데스크톱 프린터 사용 설명서를 참조하십시오 .

Antes de começar, desligue a impressora e desconecte o cabo elétrico. Ao instalar este acessório, não toque no cabeçote de impressão. Para obter mais informações, sobre o uso deste acessório, consulte o *Manual do Usuário da Impressora para Desktop PC23 e PC43*.

Прежде чем начать, выключите принтер и отсоедините шнур питания. При установке этого вспомогательного устройства не прикасайтесь к печатающей головке. Дополнительная информация об использовании устройства приведена в *руководстве пользователя настольных принтеров PC23 и PC43*.

Apague la impresora y desconecte el cable de alimentación antes de comenzar. No toque el cabezal de impresión al instalar este accesorio. Para obtener más información sobre cómo usar este accesorio, consulte el *manual del usuario para la impresora de escritorio PC23 y PC43*.

Başlamadan önce yazıcıyı kapatın ve güç kablosunu prizden çekin. Bu aksesuarı kurarken yazıcı kafasına dokunmayın. Bu aksesuarın kullanımı hakkında daha fazla bilgi için, *PC23 and PC43 Desktop Printer User Manual*.

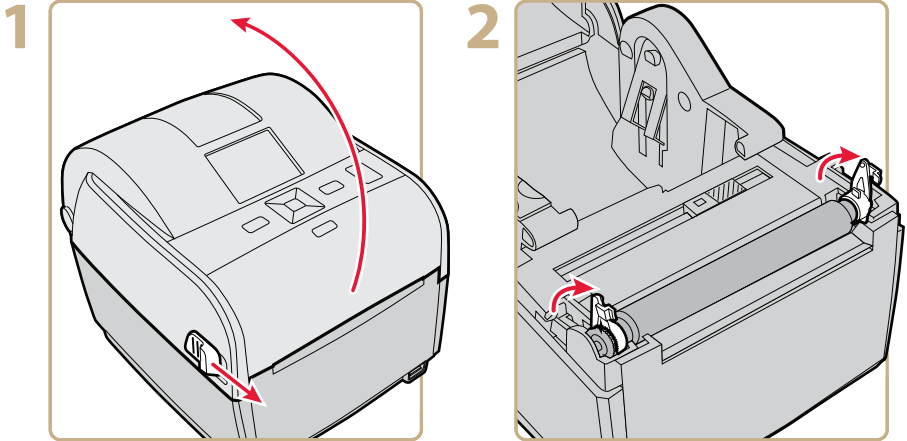

3

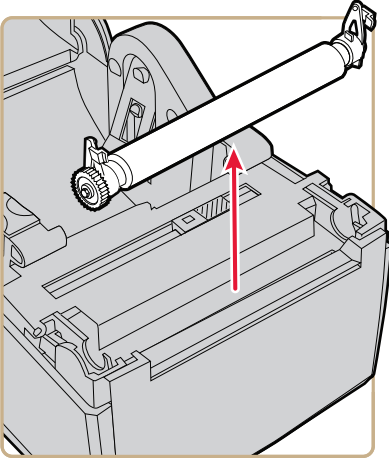

4

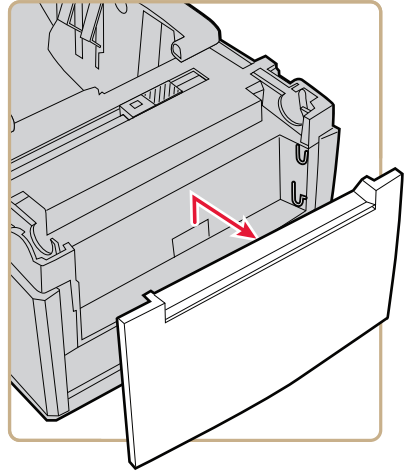

5

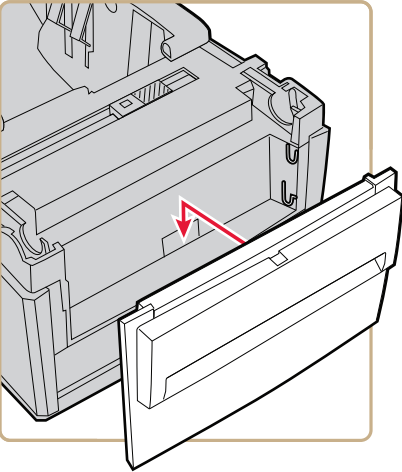

6

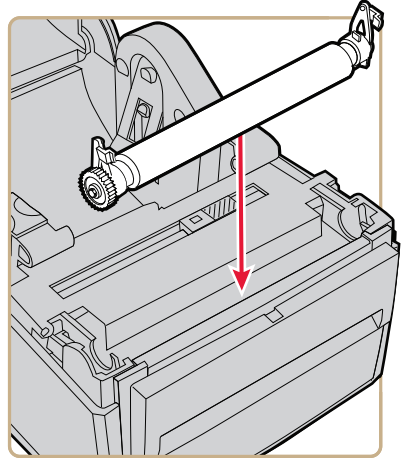

7

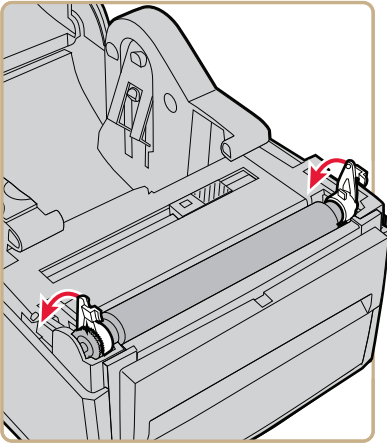

8

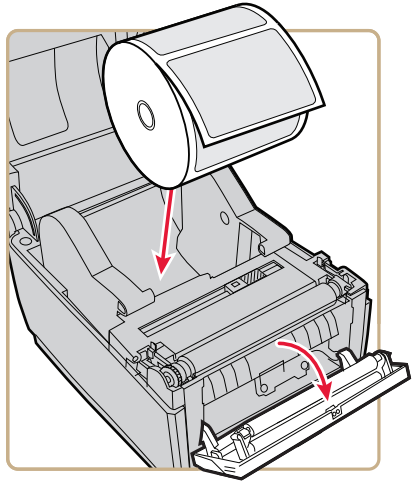

9

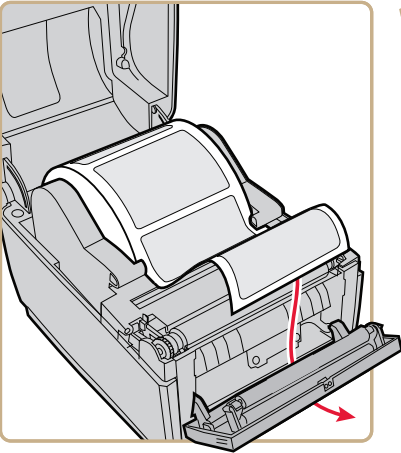

10

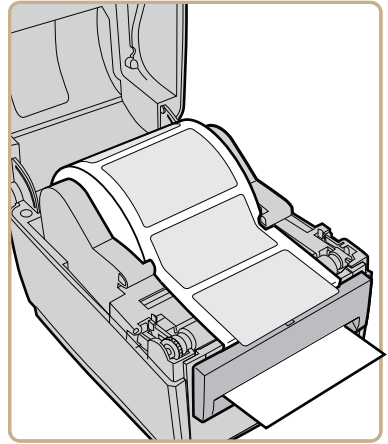

PC23d, PC43d, and PC43t Label Dispenser  
Installation Instructions



P/N 931-090-001

**Intermec**

Worldwide Headquarters  
6001 36th Avenue West  
Everett, Washington 98203  
U.S.A.

tel 425.348.2600

fax 425.355.9551

www.intermec.com

© 2011 Intermec Technologies  
Corporation. All rights reserved.

